

Duo 1

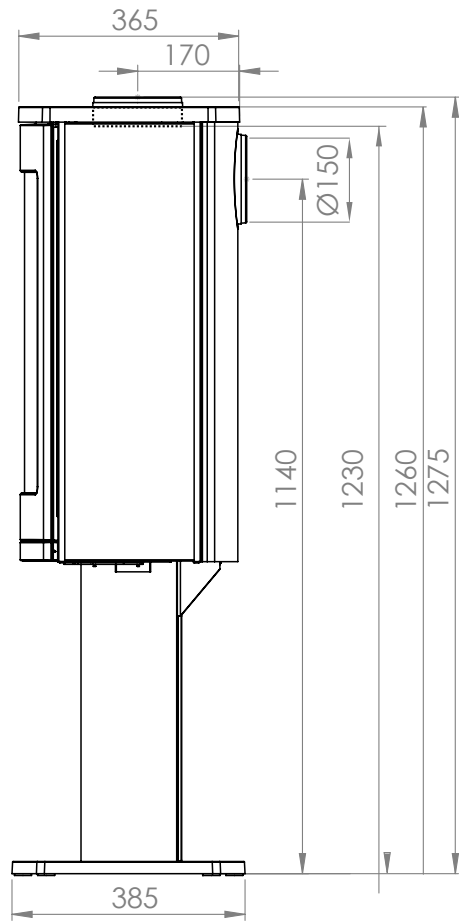

Duo 2

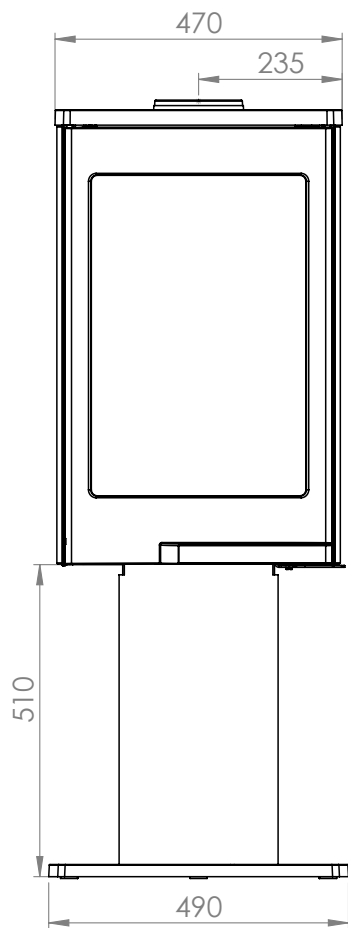
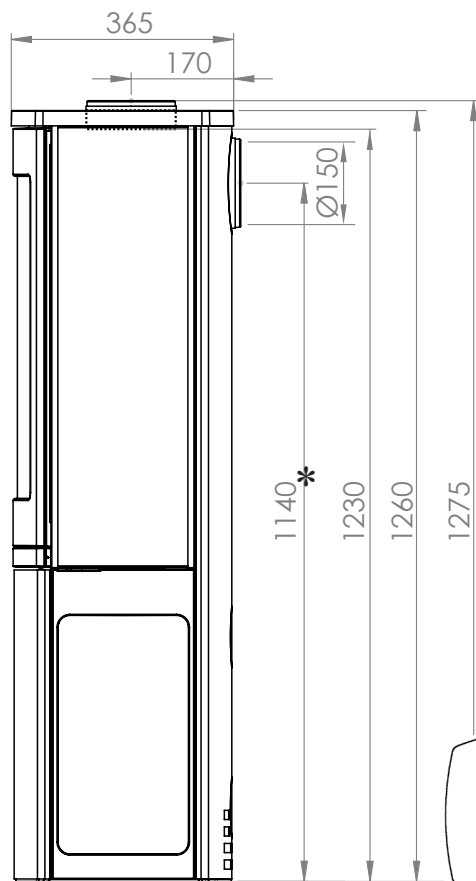
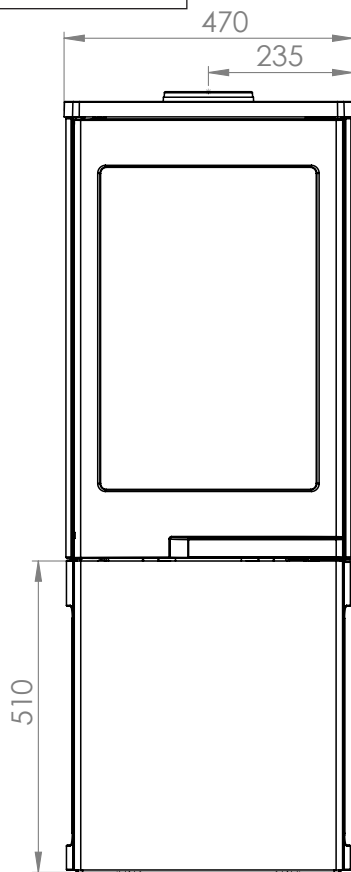

Duo 4 / 5

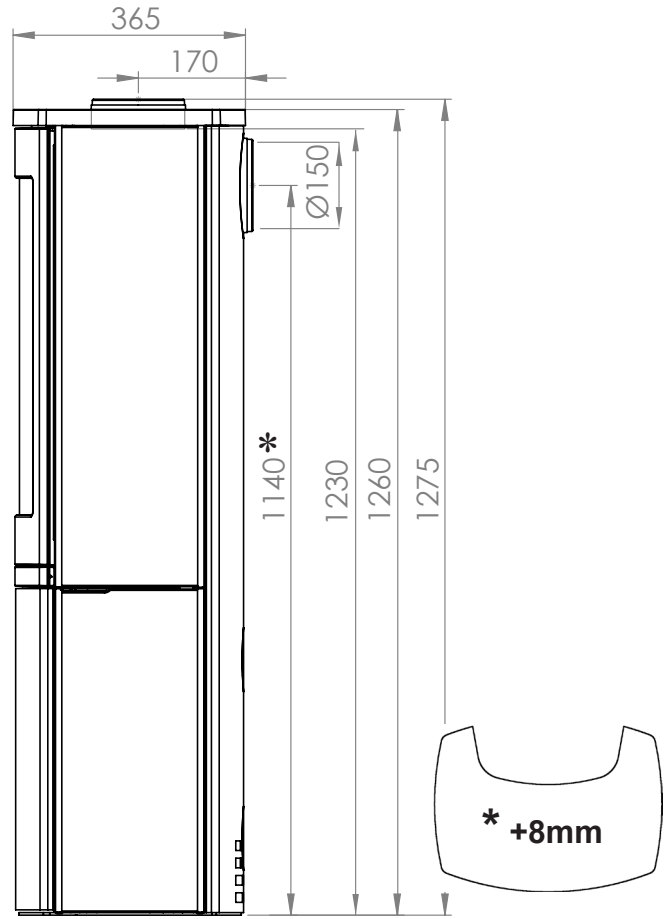
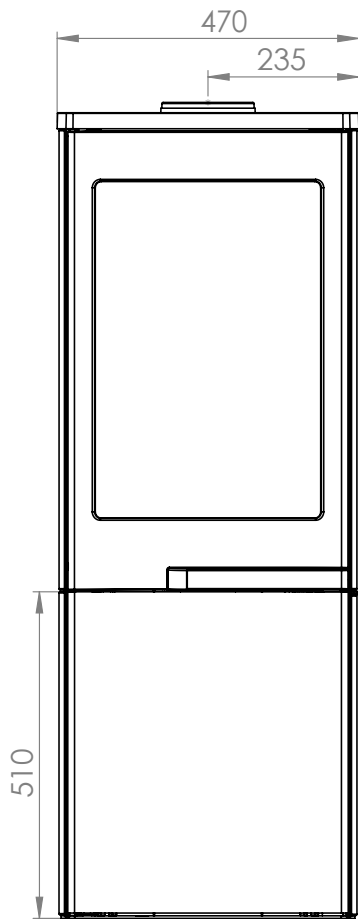

Duo 6

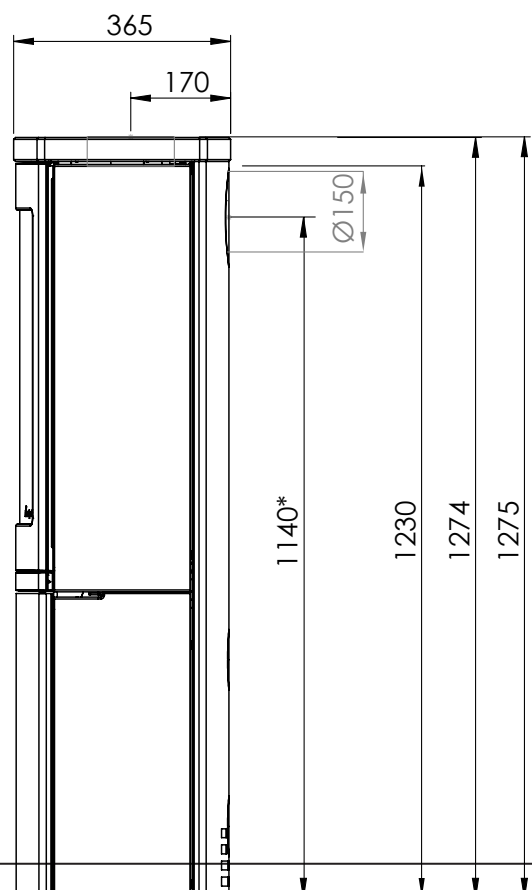
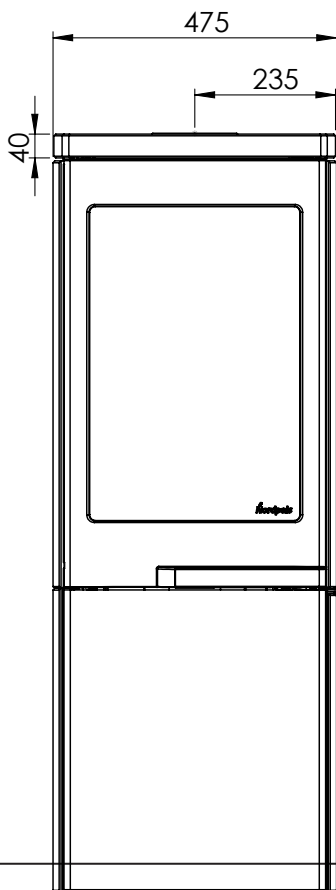



FIG 1

-  =Brannmur/Brandmur/Palomuuuri//Firewall/Mur parefeu/Hitzenschutzwand
-  =Brennbart materiale/Brændbart materiale/ Brännbart material/ Tulenarka materiaali/Combustible material
Matières combustibles/Brennbarem Material

